

# Archaeological Institute *of* America

## The R.S. Webster Lectureship



YOUR MEMBERSHIP HELPS ENSURE  
A FUTURE FOR THE PAST.

# Archaeological Institute *of* America

## Archaeological Institute of America Lecture



YOUR MEMBERSHIP HELPS ENSURE  
A FUTURE FOR THE PAST.



TRANSACTIONS  
OF THE  
AMERICAN PHILOSOPHICAL SOCIETY

HELD AT PHILADELPHIA  
FOR PROMOTING USEFUL KNOWLEDGE

---

NEW SERIES—VOLUME 64, PART 7  
1974

---

with best wishes  
and Thanks!

Derek Price

GEARS FROM THE GREEKS  
THE ANTIKYTHERA MECHANISM—A CALENDAR COMPUTER  
FROM *ca.* 80 B.C.

DEREK DE SOLLA PRICE  
*Atkins Professor of History of Science, Yale University*

---

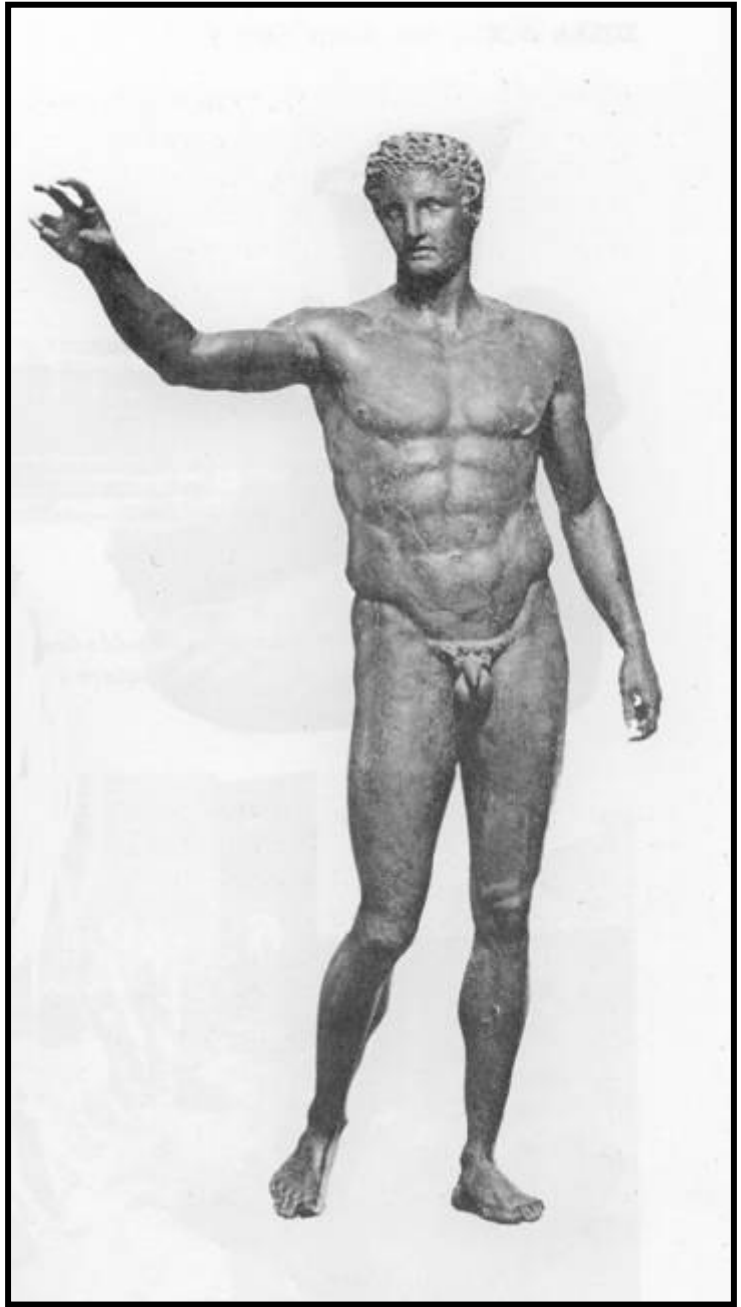
THE AMERICAN PHILOSOPHICAL SOCIETY  
INDEPENDENCE SQUARE  
PHILADELPHIA

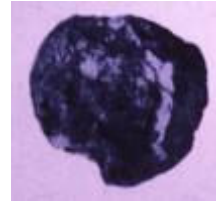
November, 1974





FIG. 4. The sponge-fishers in their *caïque* at the discovery site off Antikythera. From Svoronos, 1903.















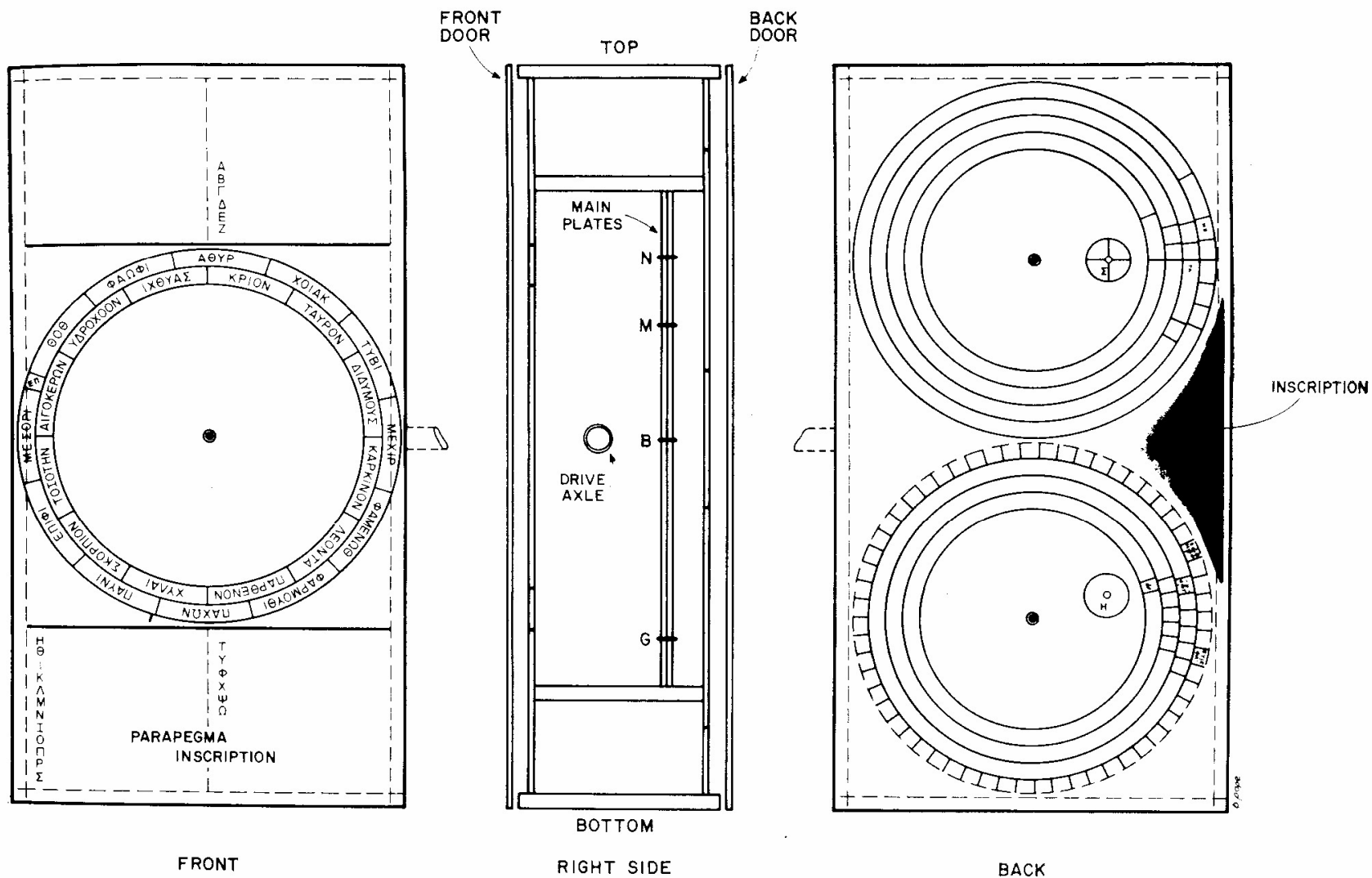
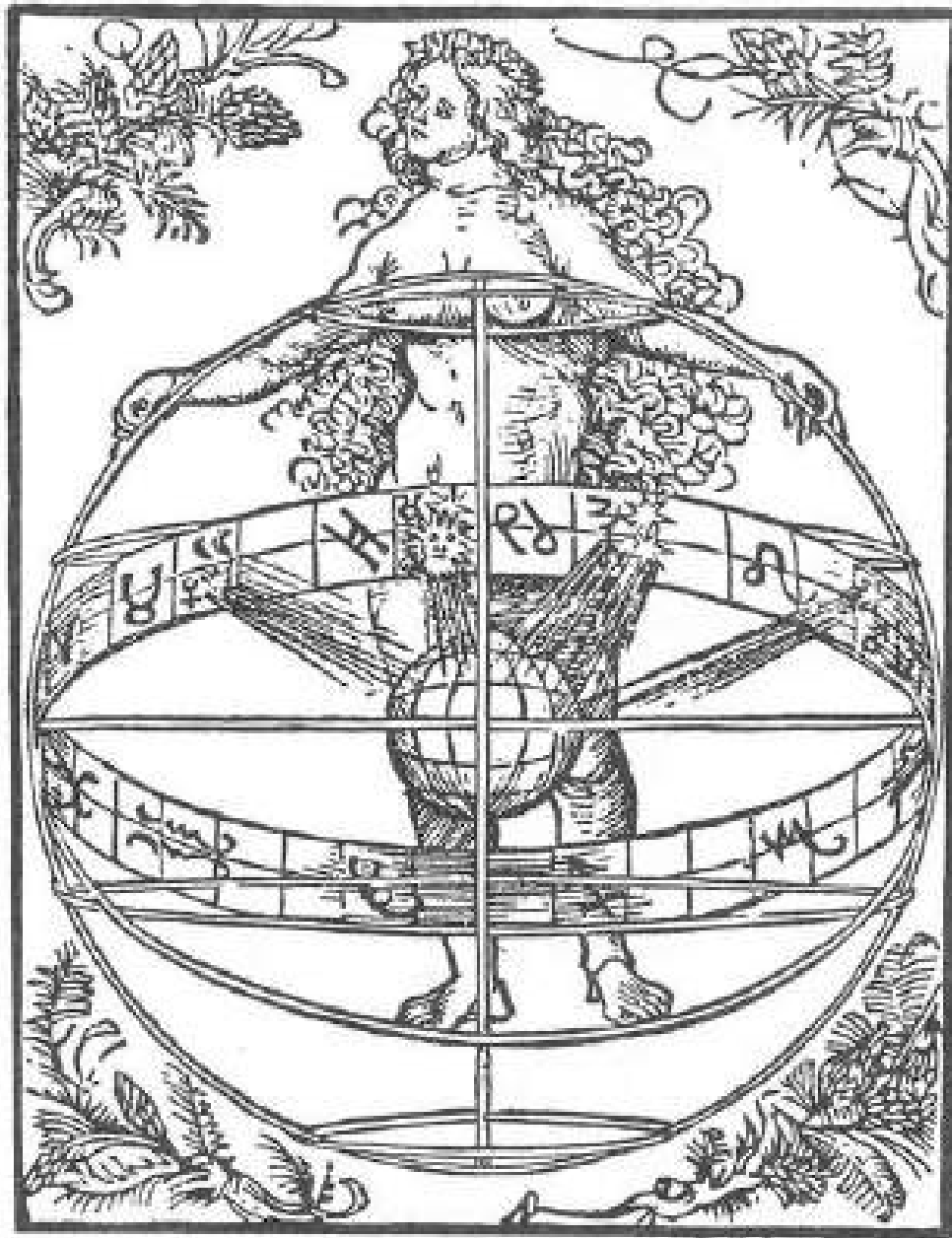
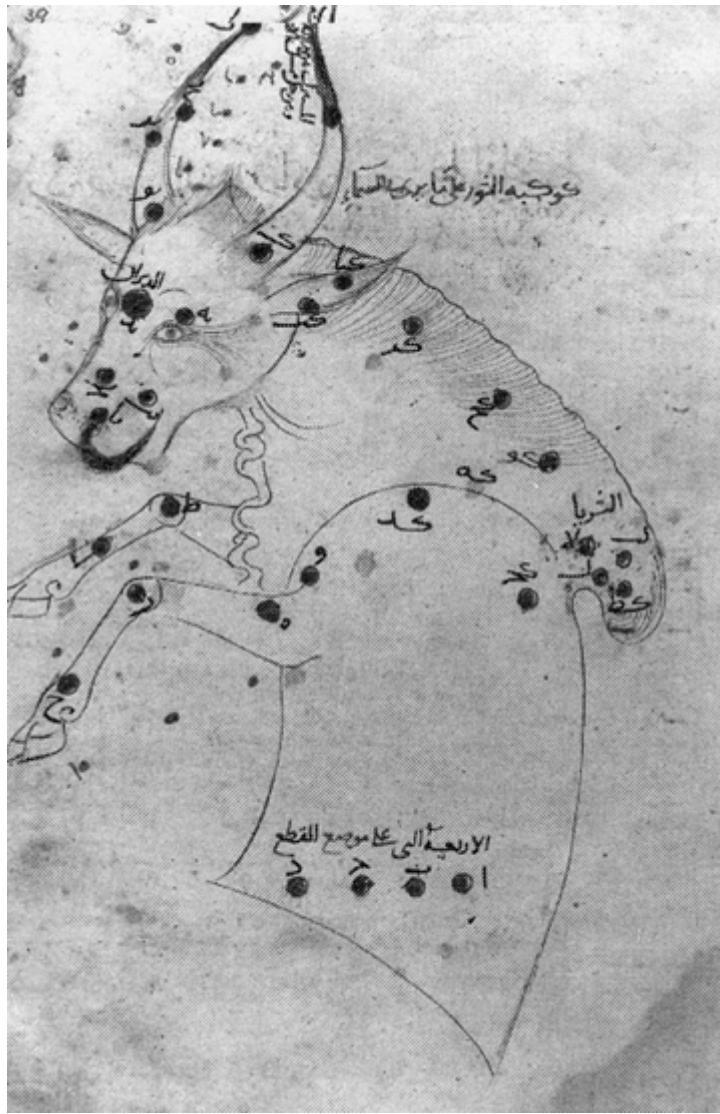
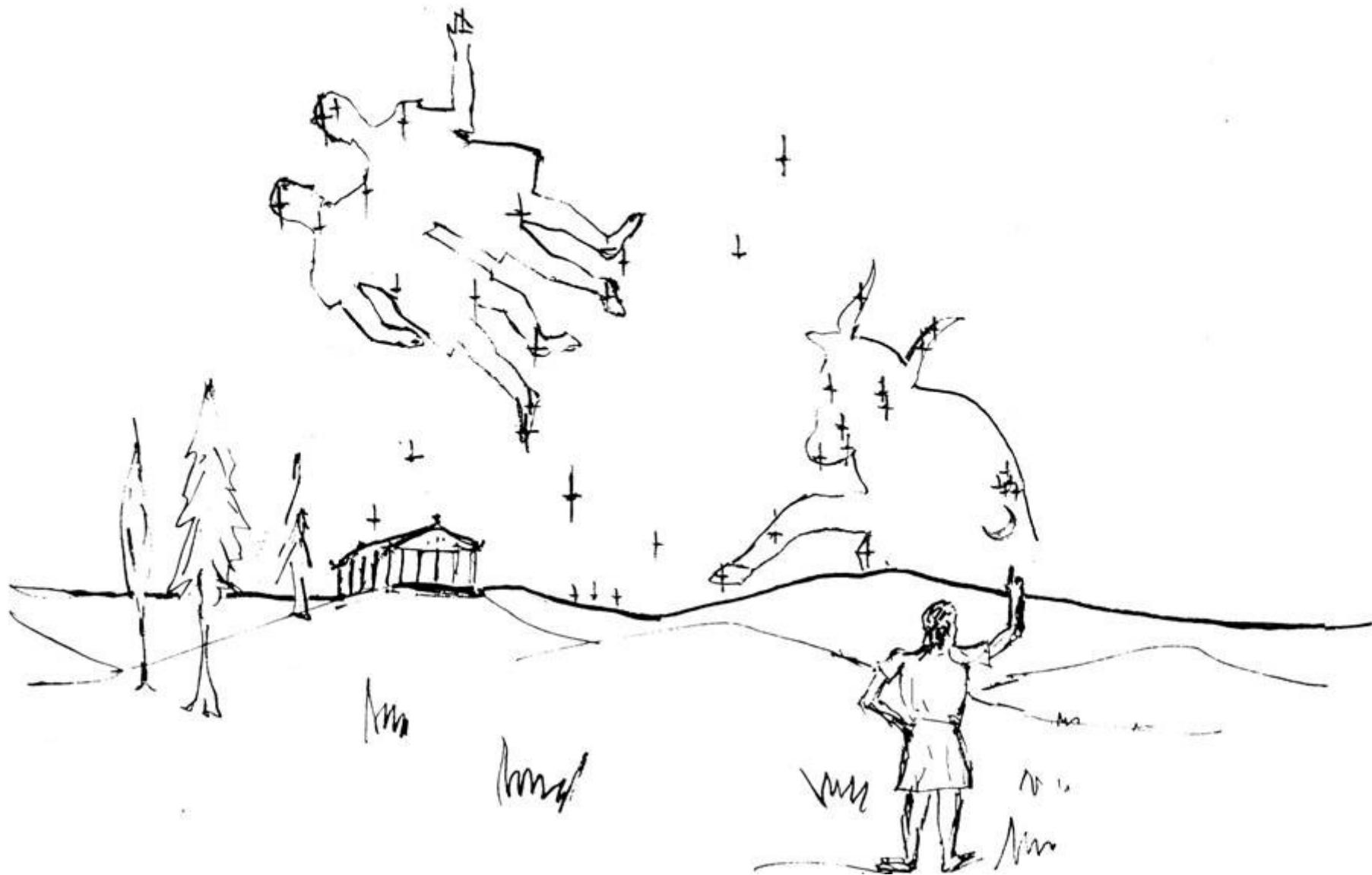


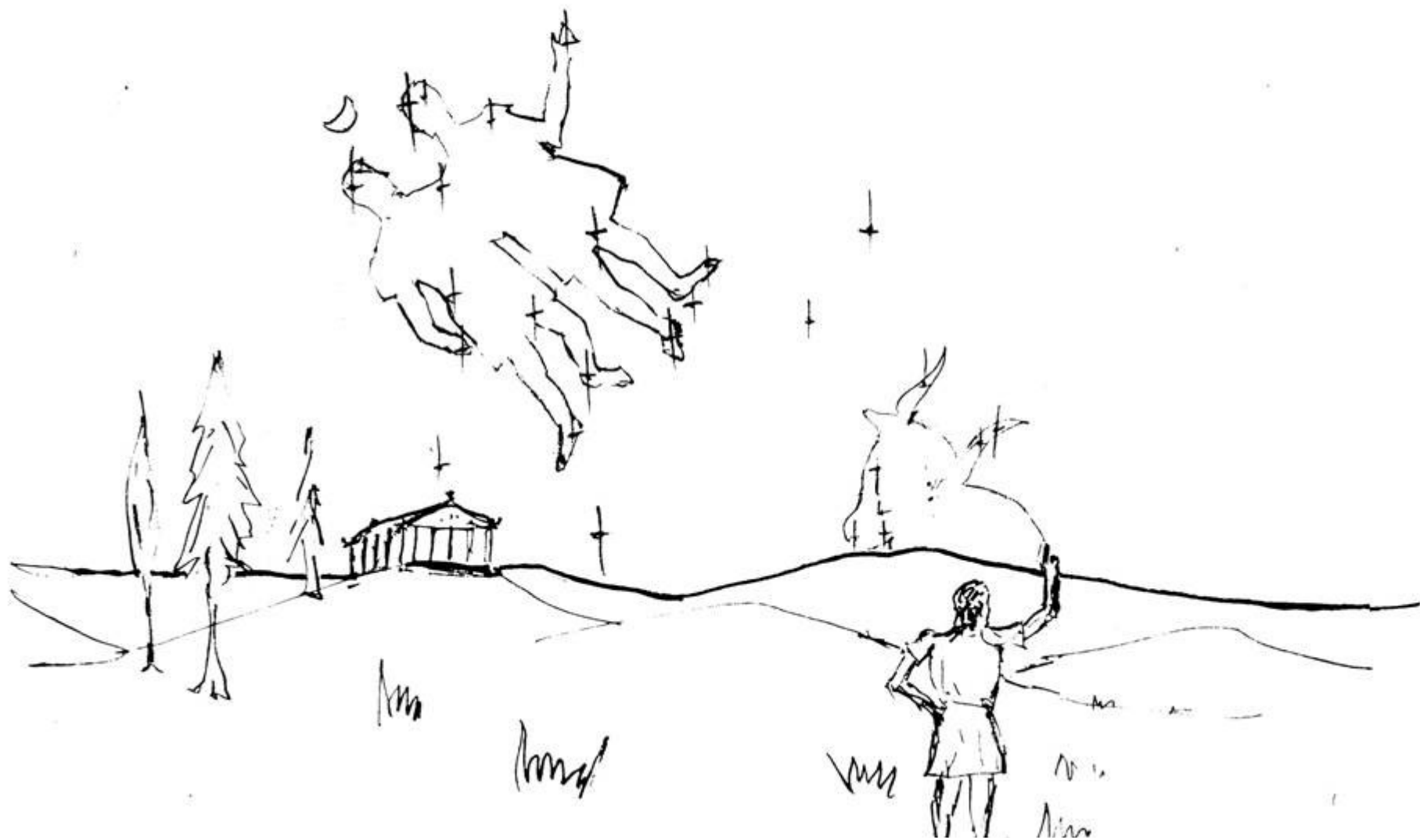
FIG. 7. Reconstruction of the dial plates and casing.

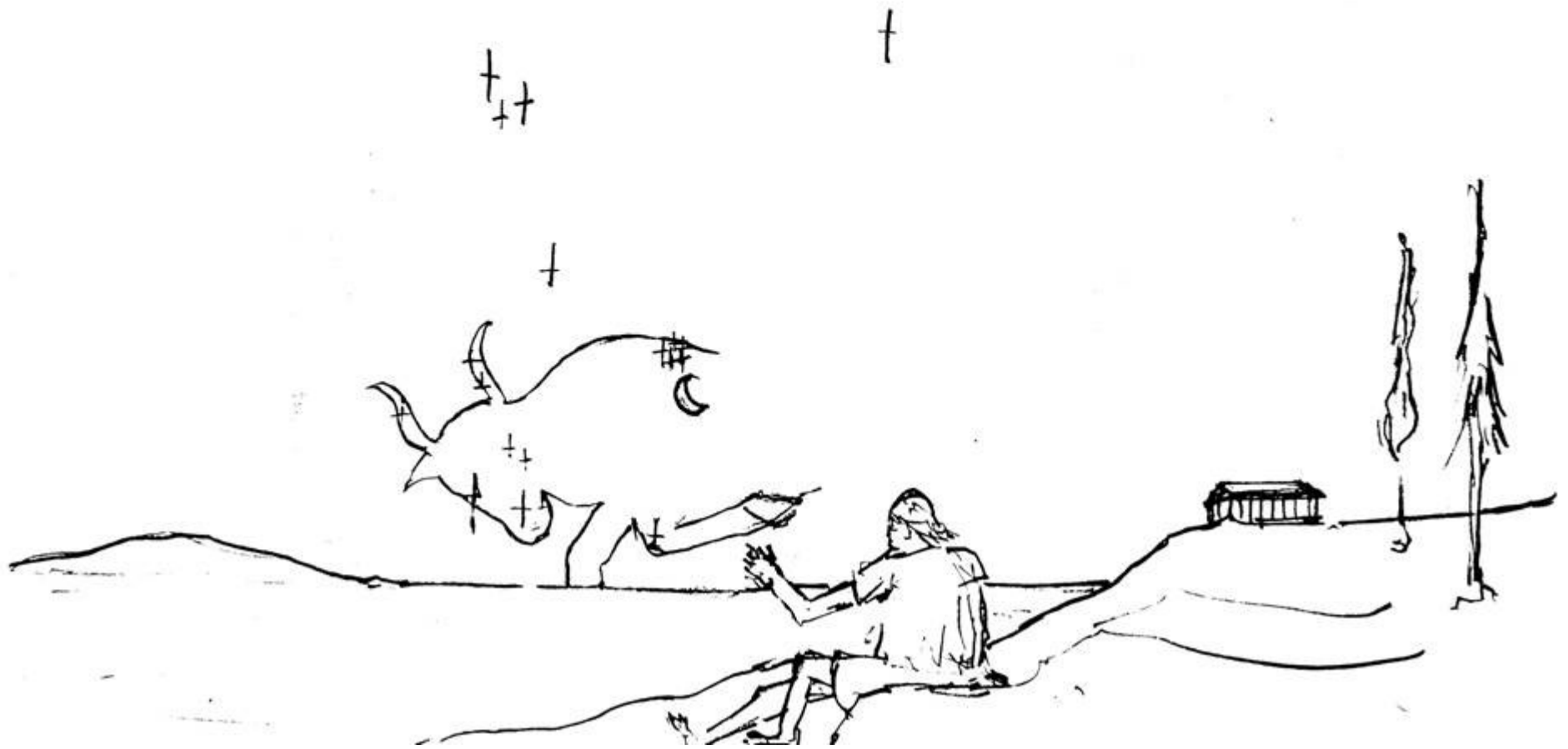


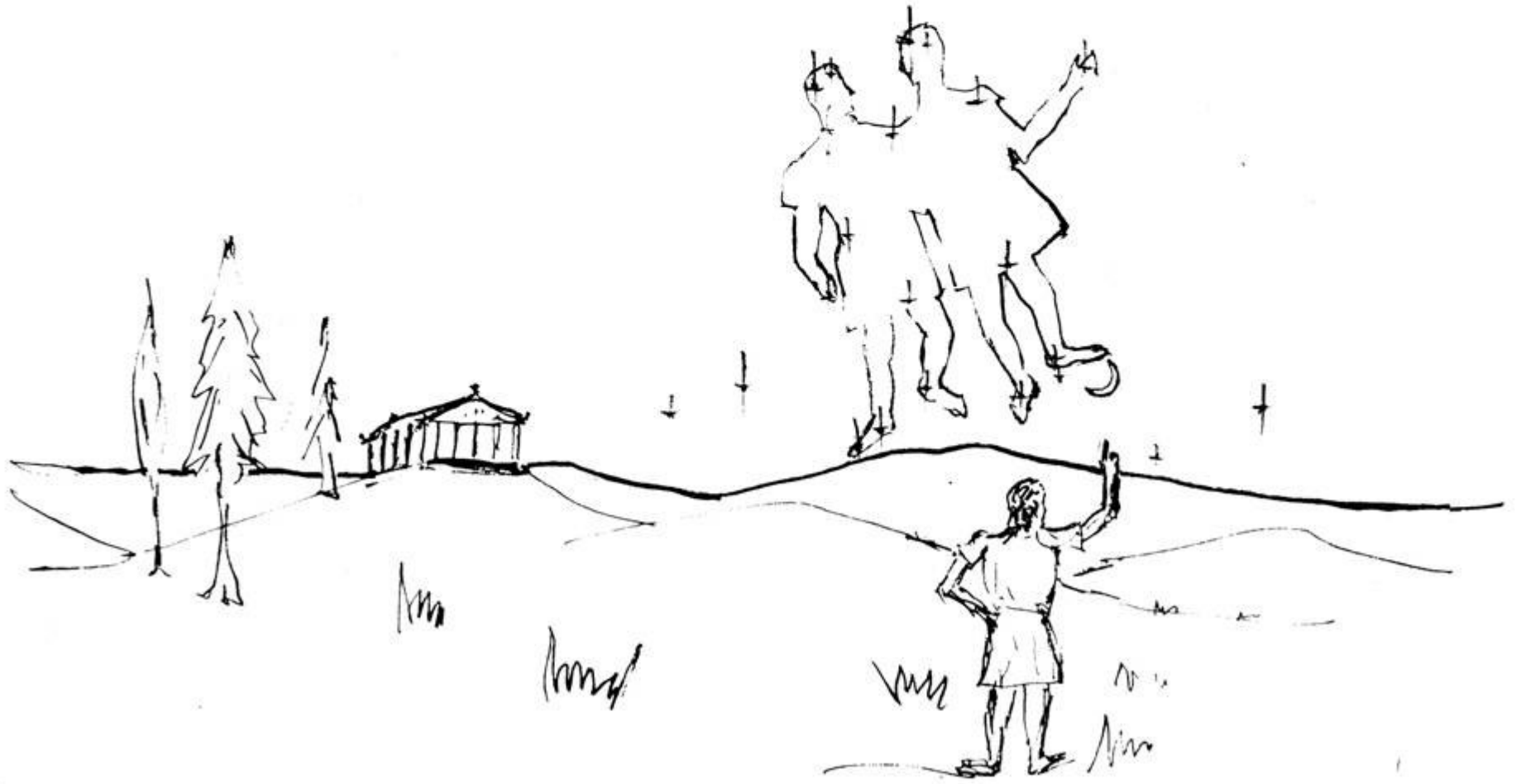












<b>1 year</b>	$\approx$	<b>365<sup>1</sup>/<sub>4</sub> days</b>
<b>1 tropical month</b>	$\approx$	<b>27<sup>1</sup>/<sub>3</sub> days</b>
<b>1 synodic month</b>	$\approx$	<b>29<sup>1</sup>/<sub>2</sub> days</b>

<b>1 year</b>	$\approx$	<b>365<math>\frac{1}{4}</math> days</b>
<b>1 tropical month</b>	$\approx$	<b>27<math>\frac{1}{3}</math> days</b>
<b>1 synodic month</b>	$\approx$	<b>29<math>\frac{1}{2}</math> days</b>

<b>19 years</b>		<b>= 235 synodic months</b>
<b>19 years</b>	<b>= (235 + 19)</b>	<b>= 254 tropical months</b>

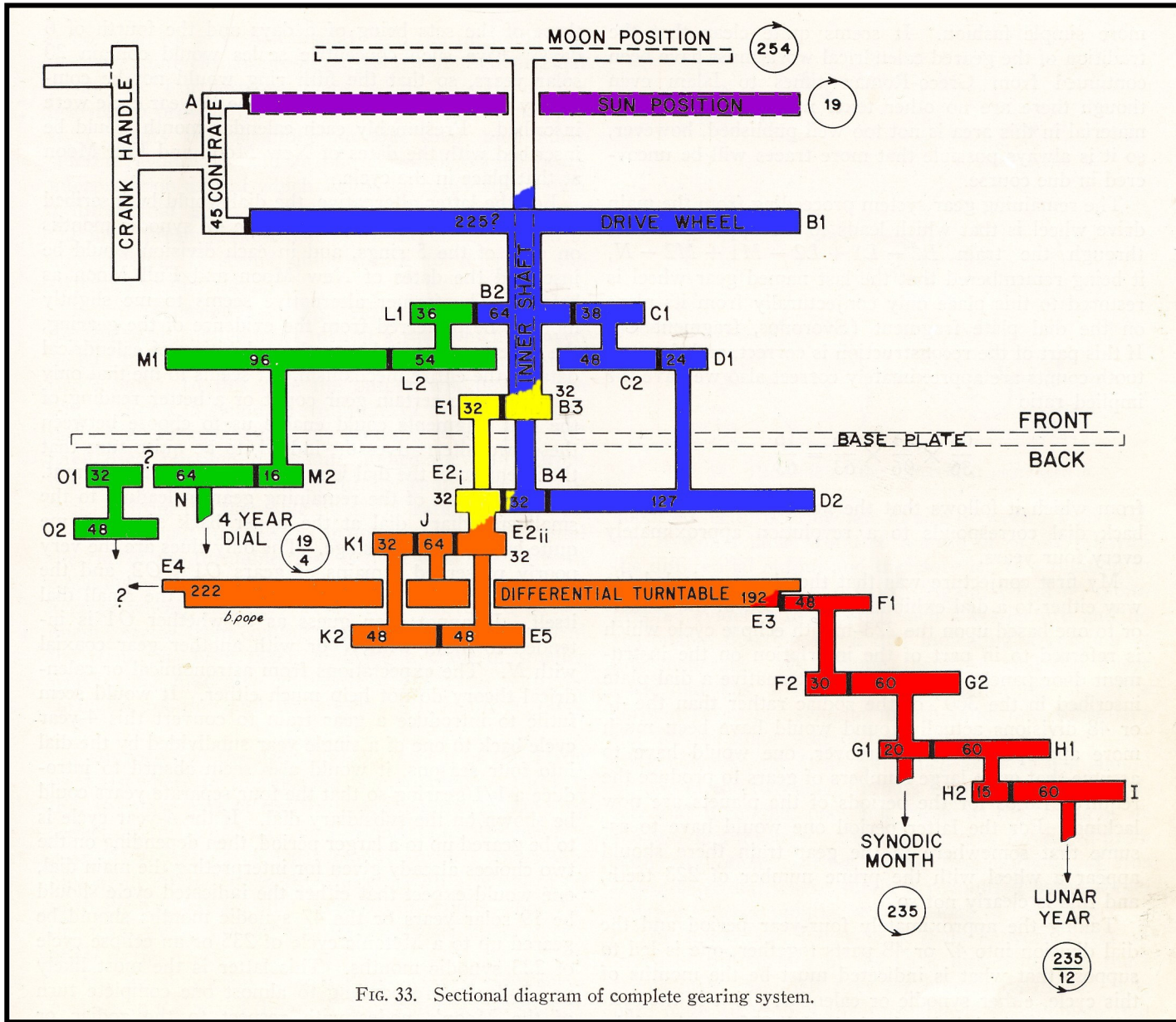


FIG. 33. Sectional diagram of complete gearing system.

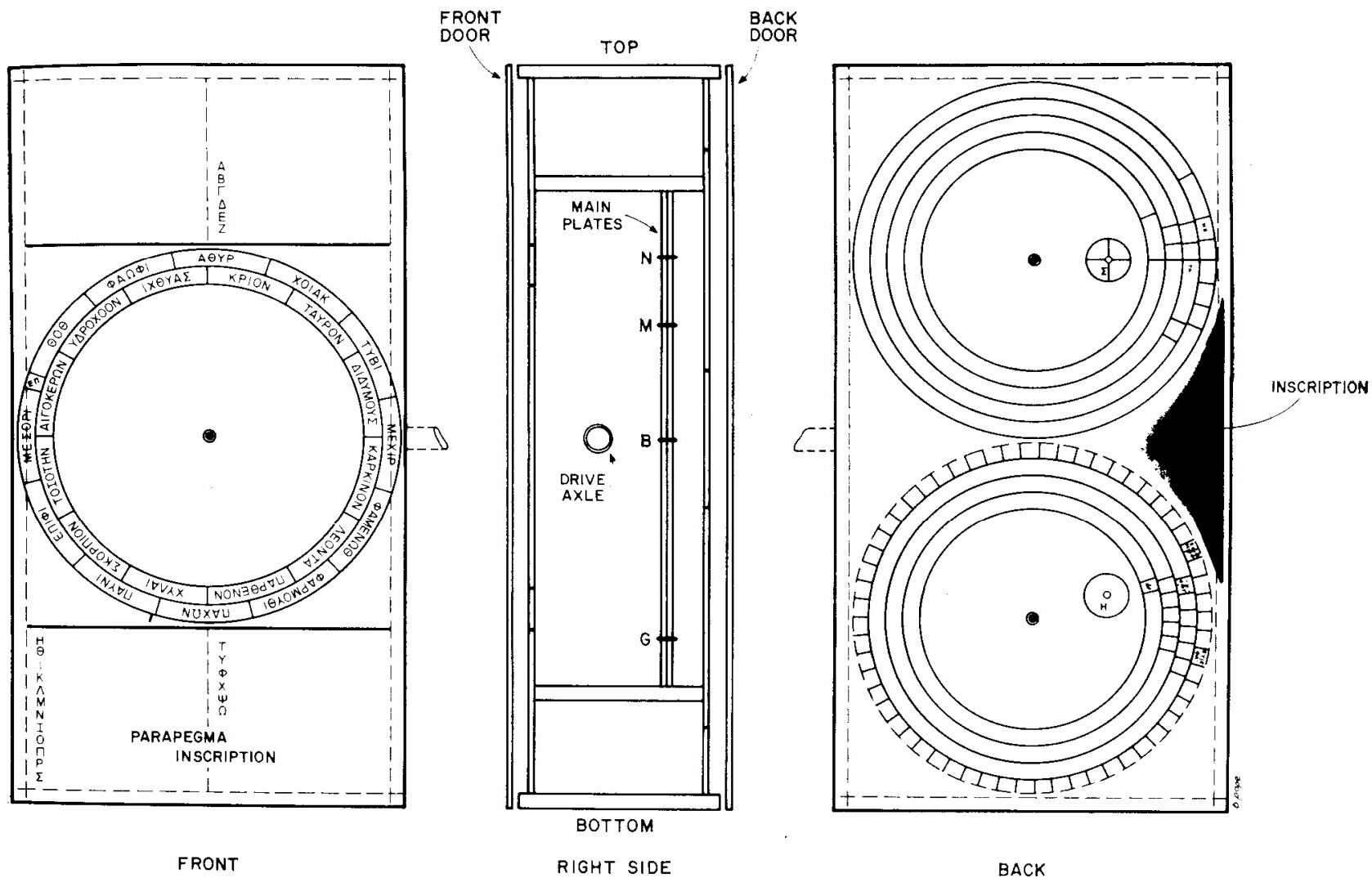


FIG. 7. Reconstruction of the dial plates and casing.





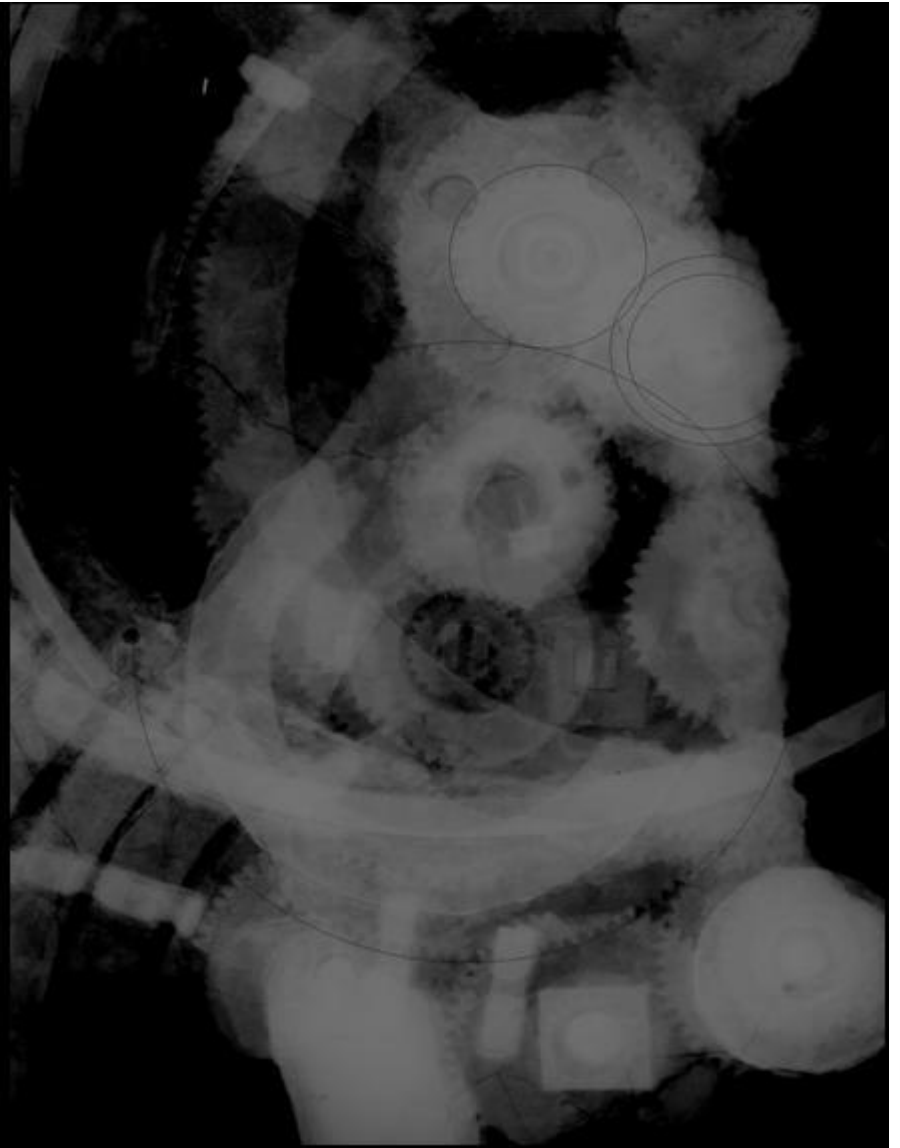
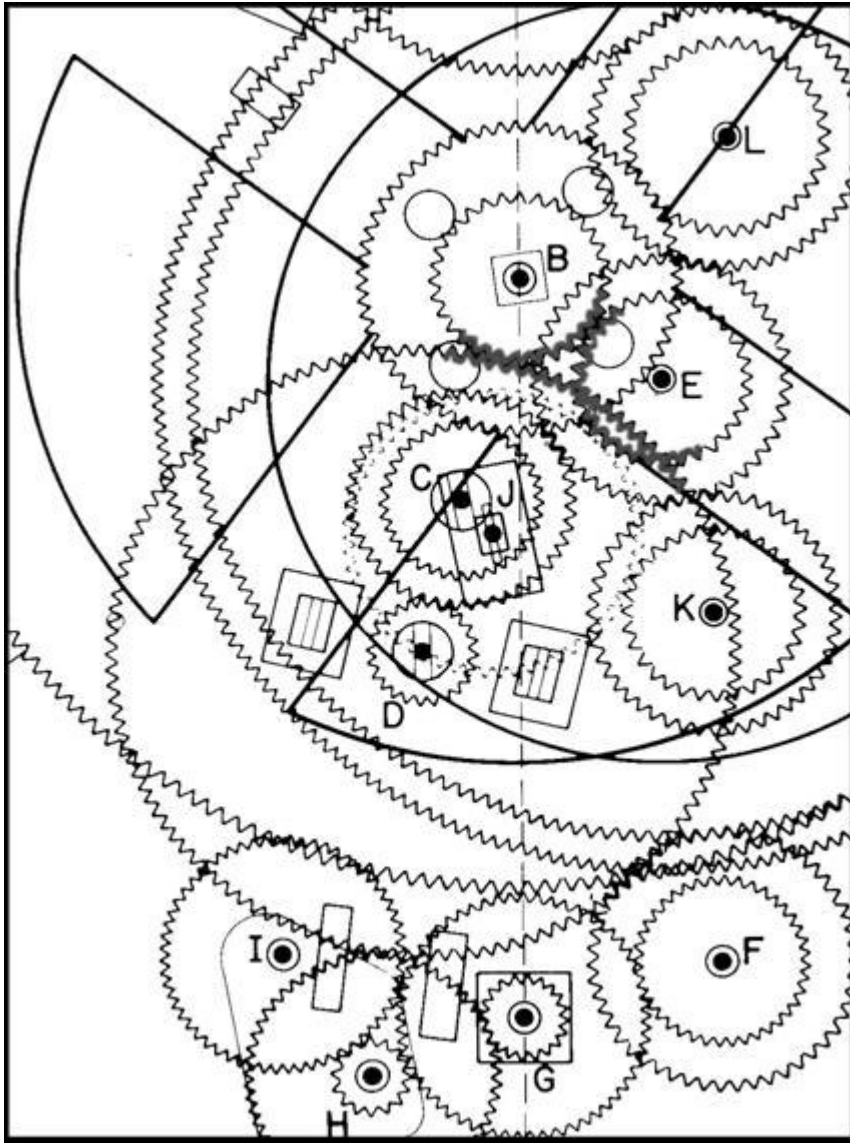














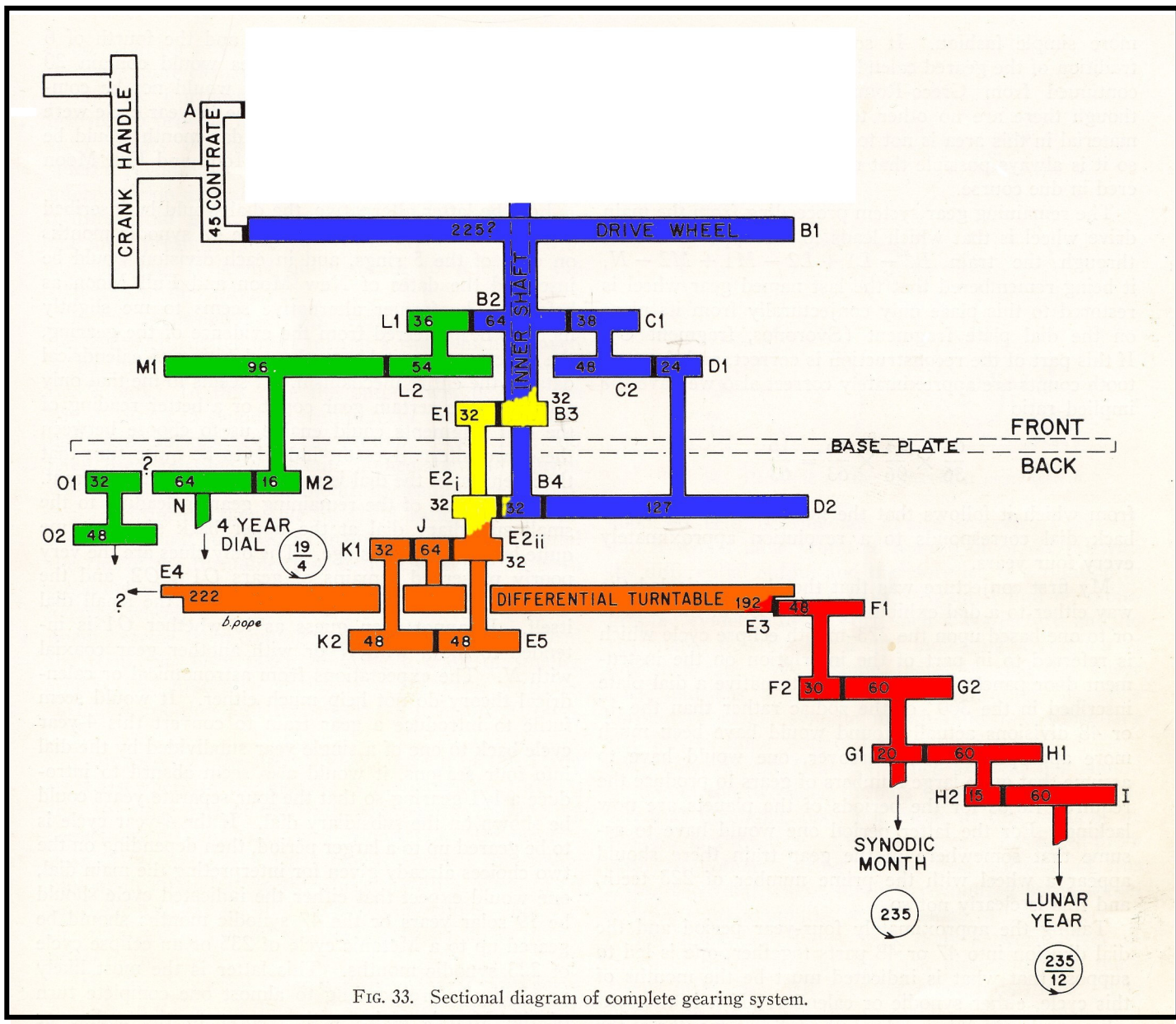
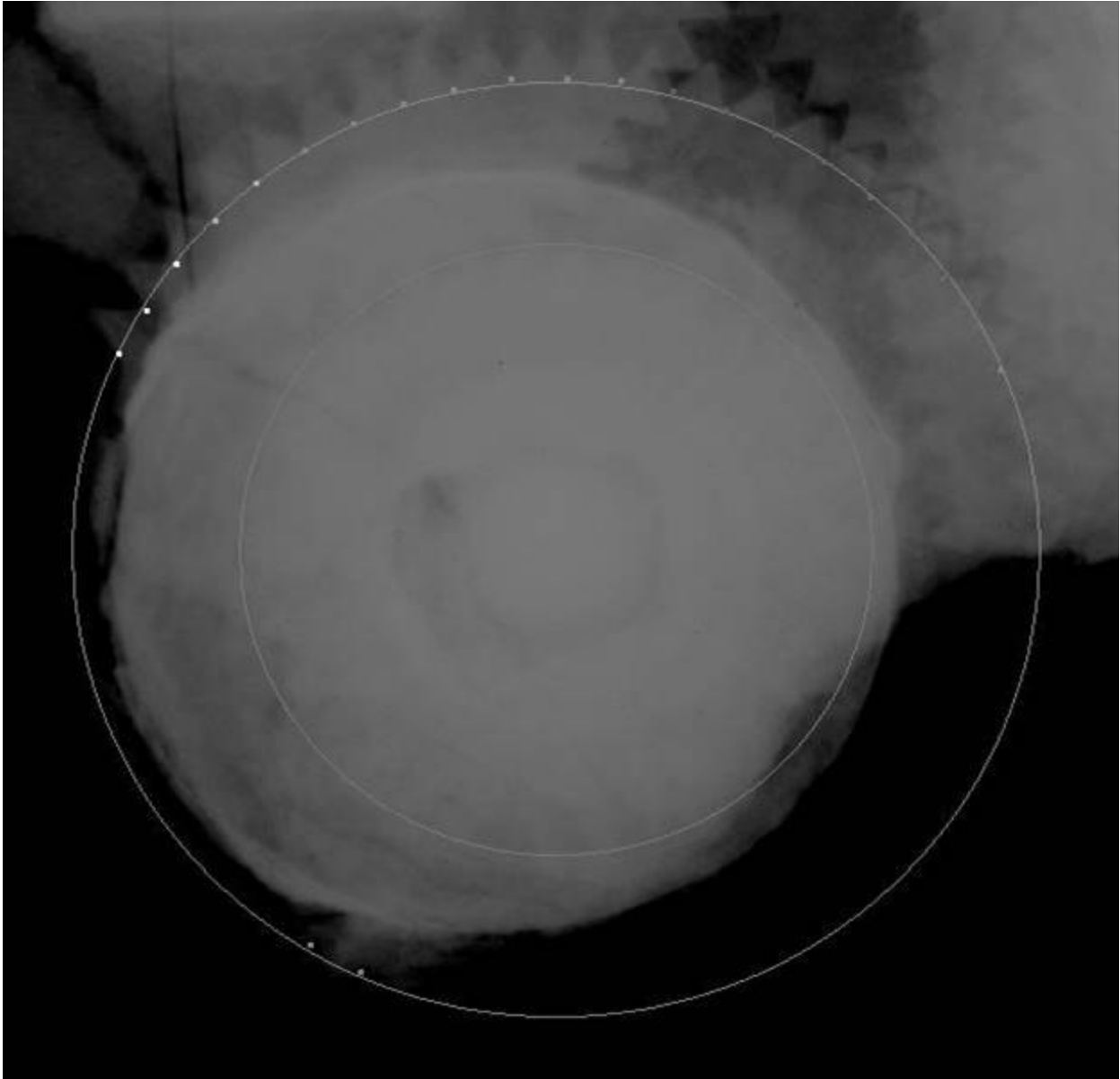
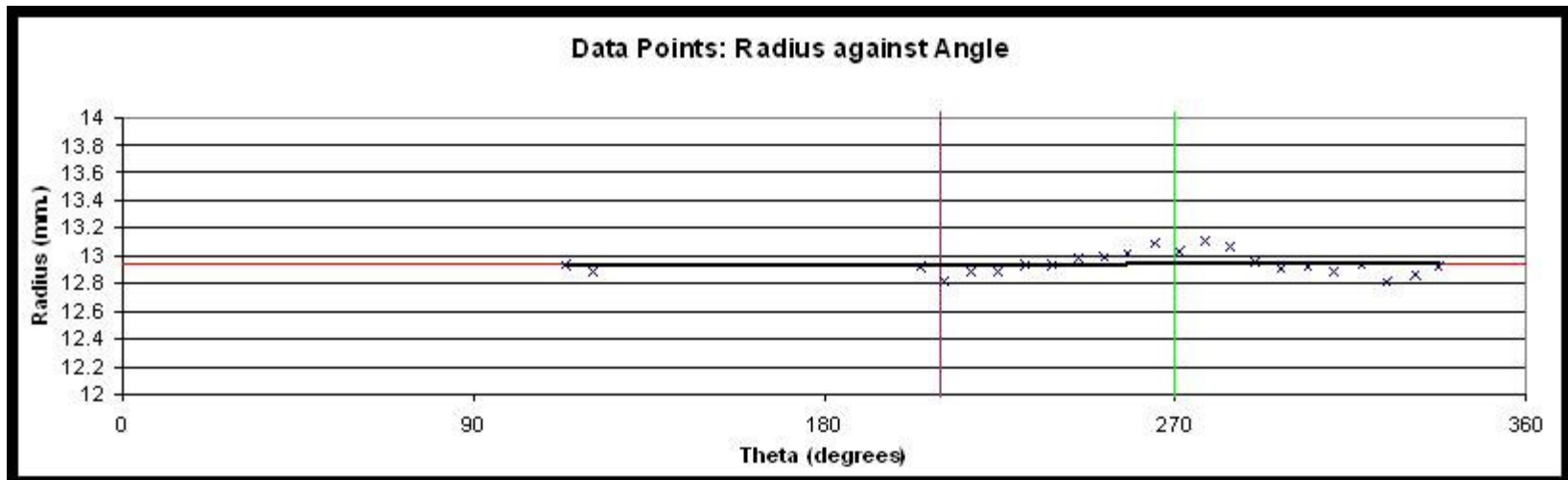


FIG. 33. Sectional diagram of complete gearing system.

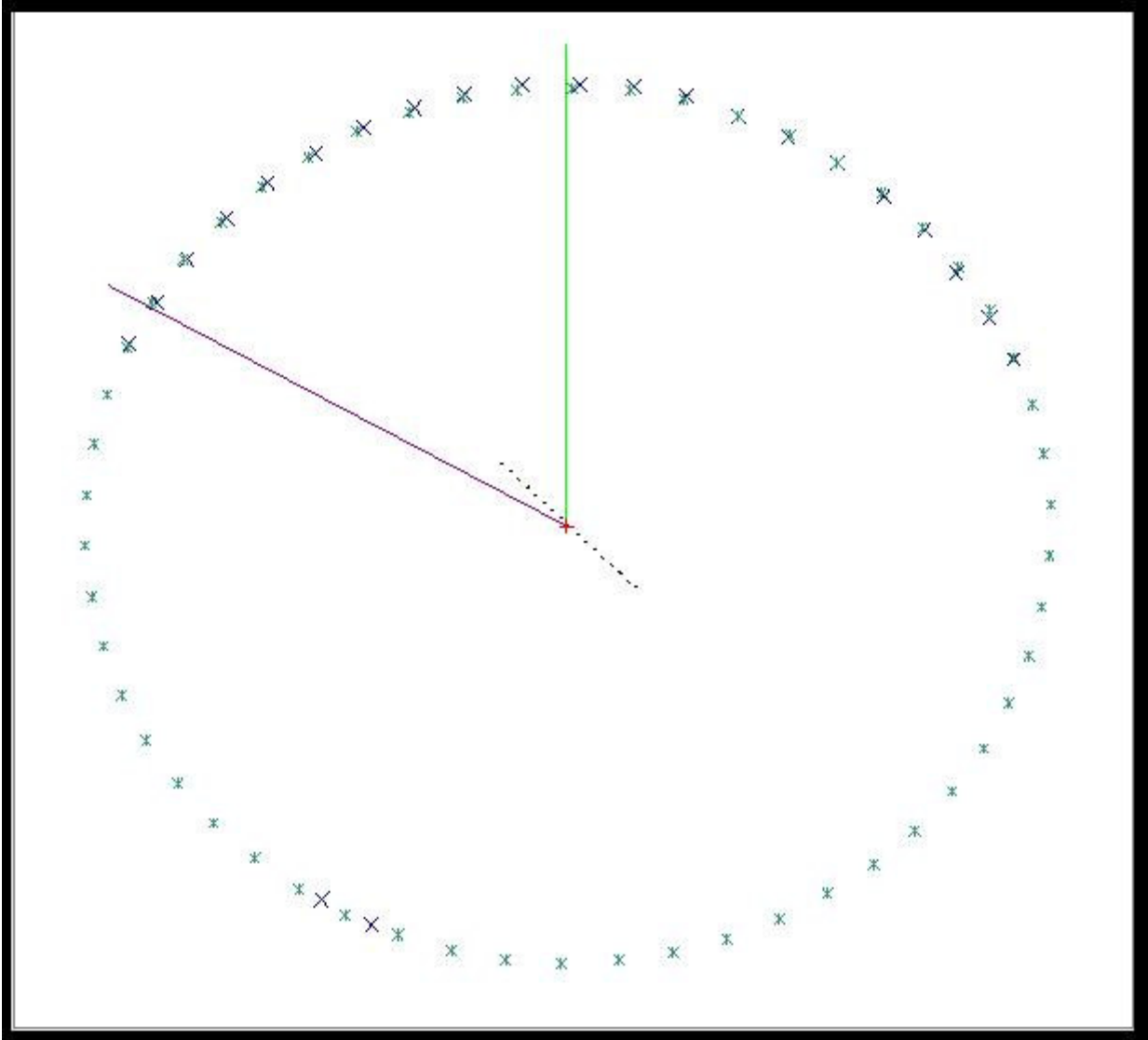


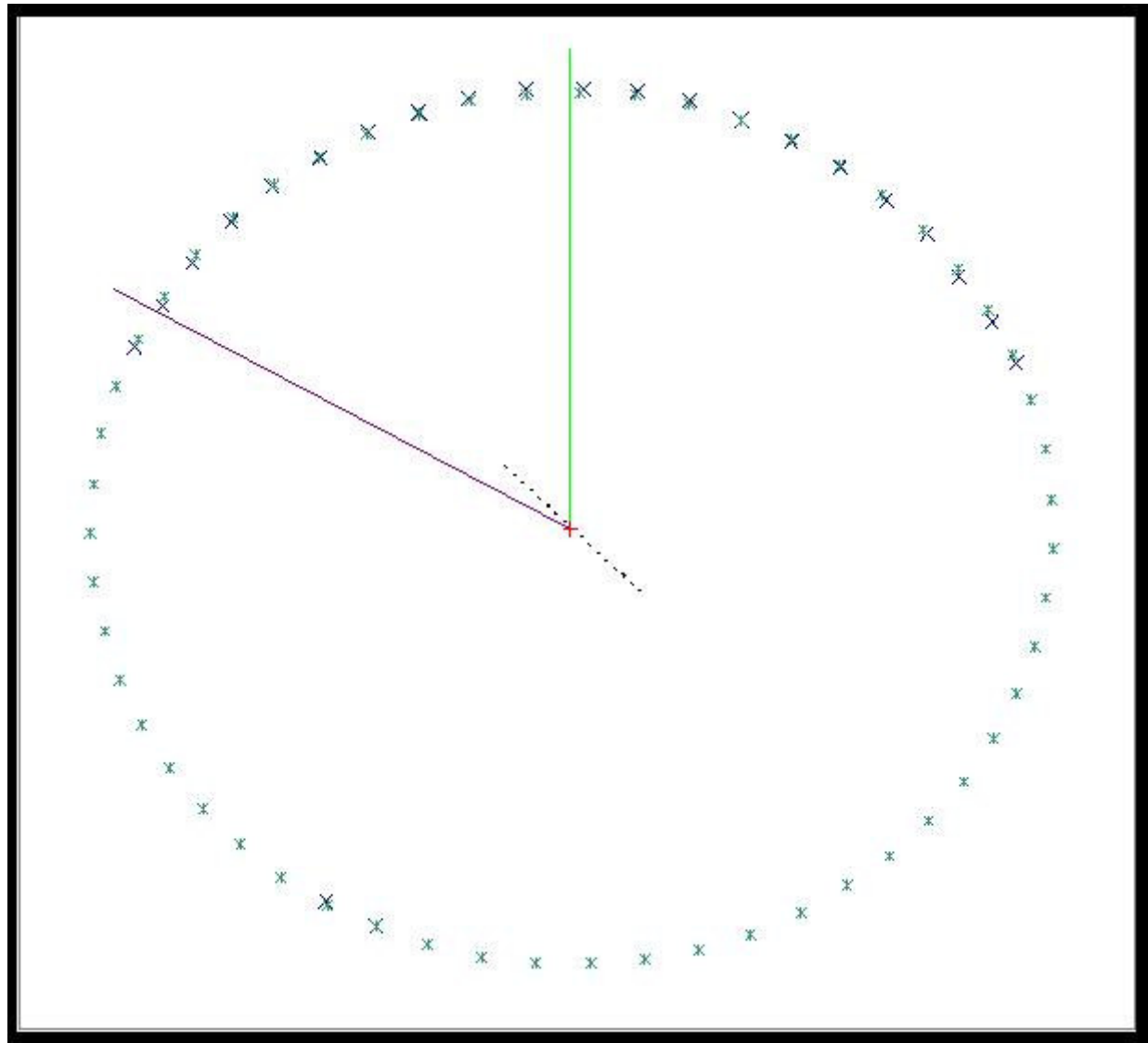


Finding Centre, and testing for Roundness:  
centre is adjusted to make trend line horizontal.



<b>Data point</b>	<b>X</b>	<b>Y</b>	<b>θ</b>	<b>dθ</b>	<b>Mean teeth</b>	<b>Suggested</b>	<b>Toothcount</b>
23	9.6	27	113.9489949	136.3677032	20.48	20	20
22	8.25	26.25	120.803649	6.854654067	1.03	1	21
1	3.1	9.8	204.6017333	83.79808436	12.58	13	34
2	3.85	8.6	210.8870965	6.285363105	0.94	1	35
3	4.65	7.3	217.6878451	6.800748685	1.02	1	36
4	5.7	6.1	224.7799953	7.092150211	1.07	1	37
5	6.8	5.05	231.5269124	6.746917049	1.01	1	38
6	8.1	4.15	238.5347282	7.007815839	1.05	1	39
7	9.4	3.4	245.1724472	6.637719017	1.00	1	40
8	10.75	2.85	251.6068831	6.434435835	0.97	1	41
9	12.1	2.45	257.8099907	6.203107652	0.93	1	42
10	13.65	2.15	264.7381783	6.928187579	1.04	1	43
11	15.15	2.15	271.318933	6.580754731	0.99	1	44
12	16.6	2.2	277.6784767	6.359543643	0.96	1	45
13	18	2.5	283.9511561	6.272679364	0.94	1	46
14	19.4	3.05	290.5612215	6.610065404	0.99	1	47
15	20.75	3.7	297.2003214	6.639099925	1.00	1	48
16	22.05	4.45	303.8622372	6.661915815	1.00	1	49
17	23.3	5.45	310.9726197	7.110382526	1.07	1	50
18	24.4	6.45	317.568439	6.595819234	0.99	1	51
19	25.25	7.7	324.2751497	6.706710771	1.01	1	52
20	26.15	9.05	331.5211482	7.245998509	1.09	1	53
21	26.8	10.25	337.5812917	6.06014344	0.91	1	54
<b>Centre</b>	14.15	15.18					



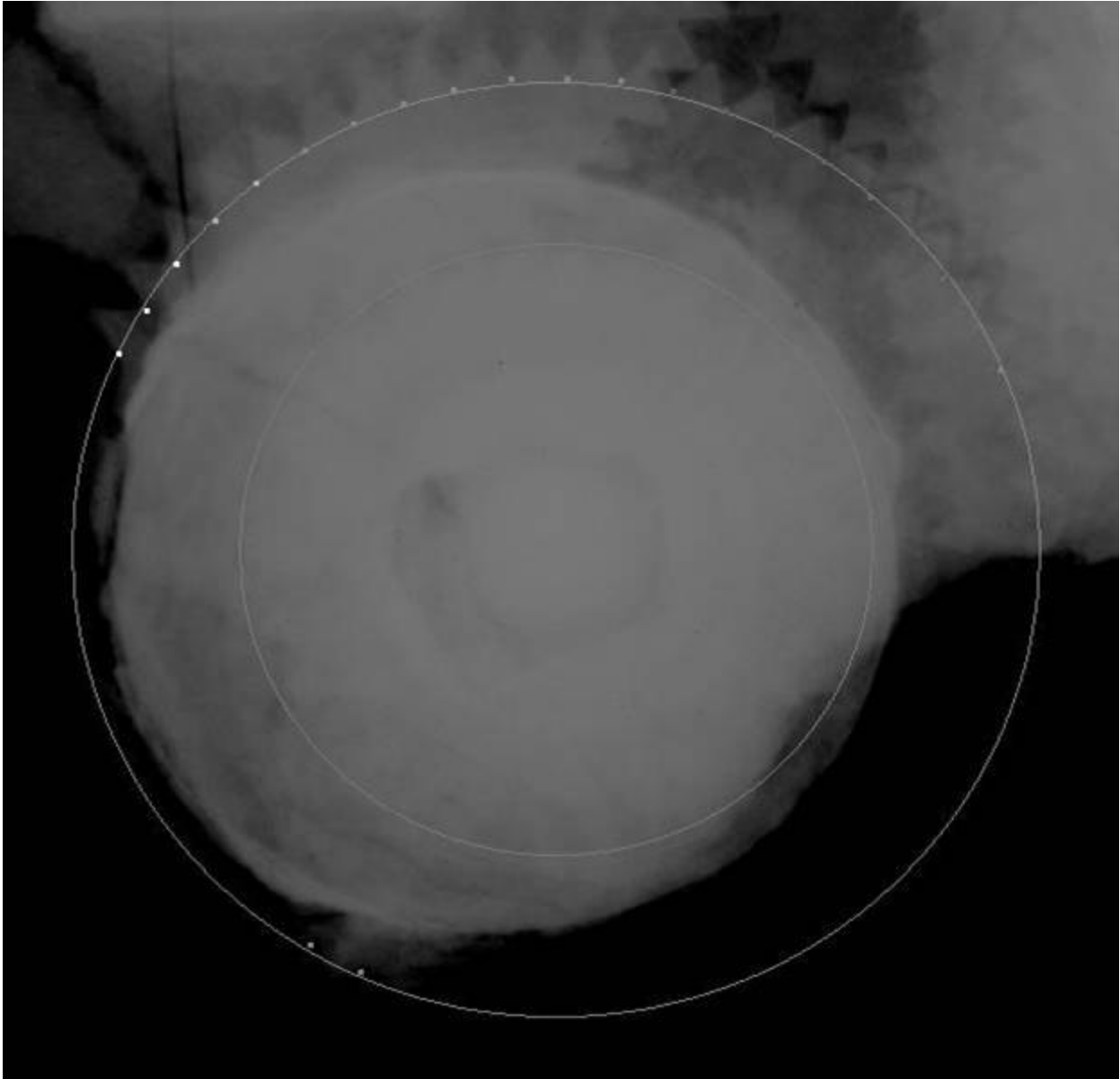


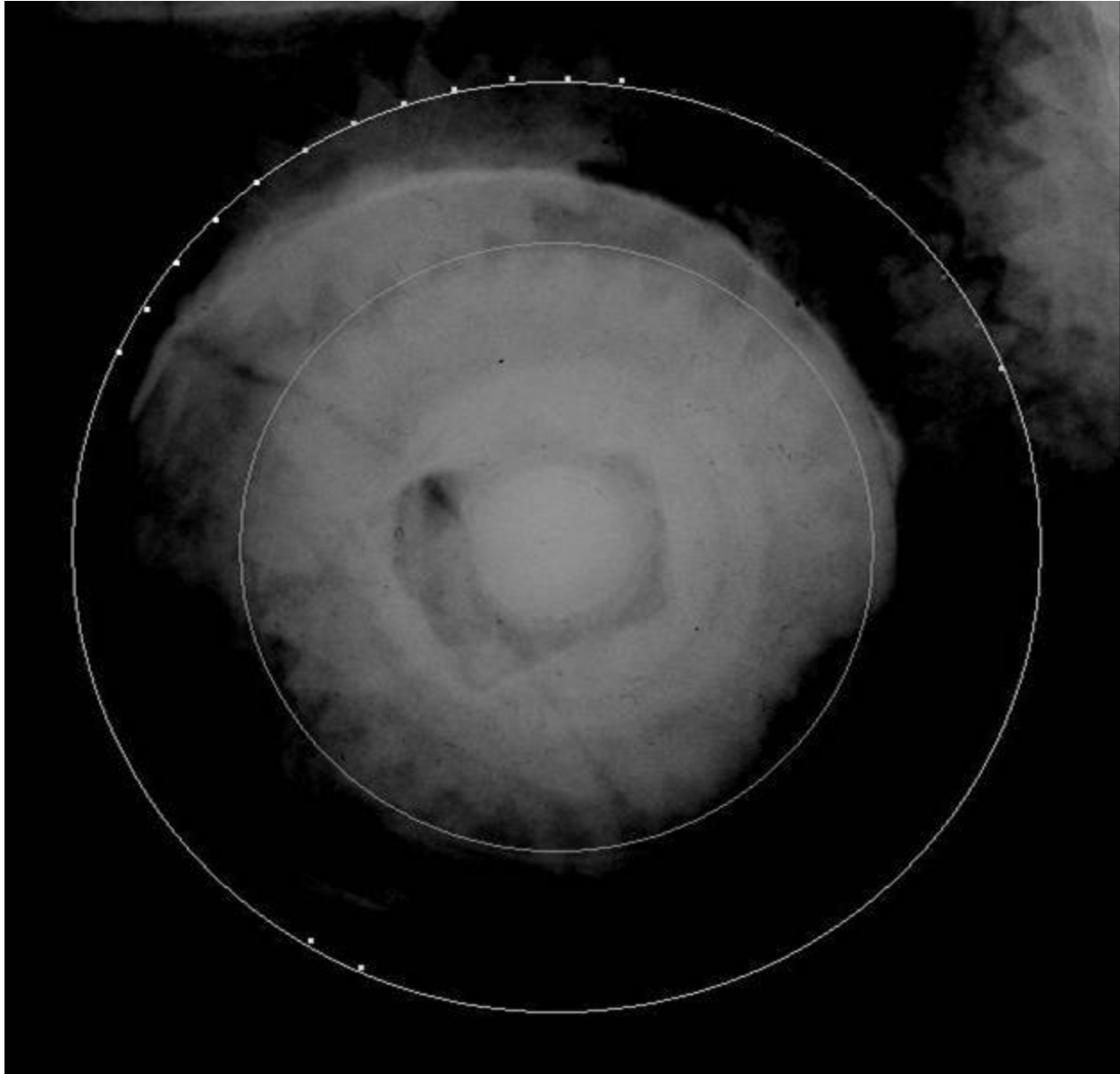
## from: **Provisional Wheel Counts ...**

**F1** Latest analysis F1 26vii03. Table gives 54, with lacunae of 12.58 and 20.48. There is a pair of adjacent points, otherwise isolated, between these two gaps. On the plot, 54 is seen to fit these two points rather badly, and 55 fits them better while also fitting the other points reasonably well. The lacunae lead to an uncertainty of  $\pm 3$ . Hence: limits 51, 58; preferred value 54 or 55. 9ix03.

**F2** Certainly 30 teeth; all seen. Analysis 18vii03.

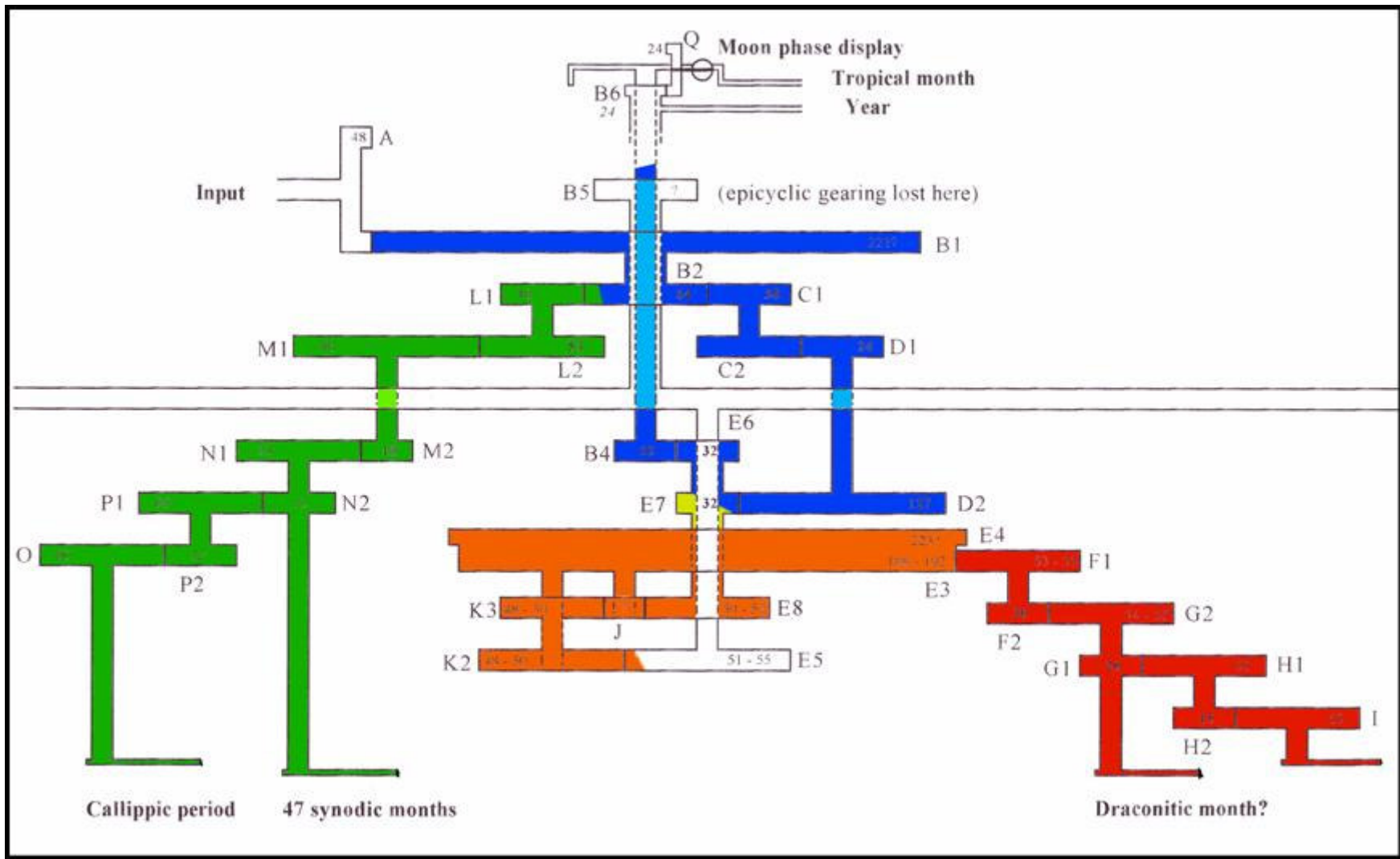
and so on ...

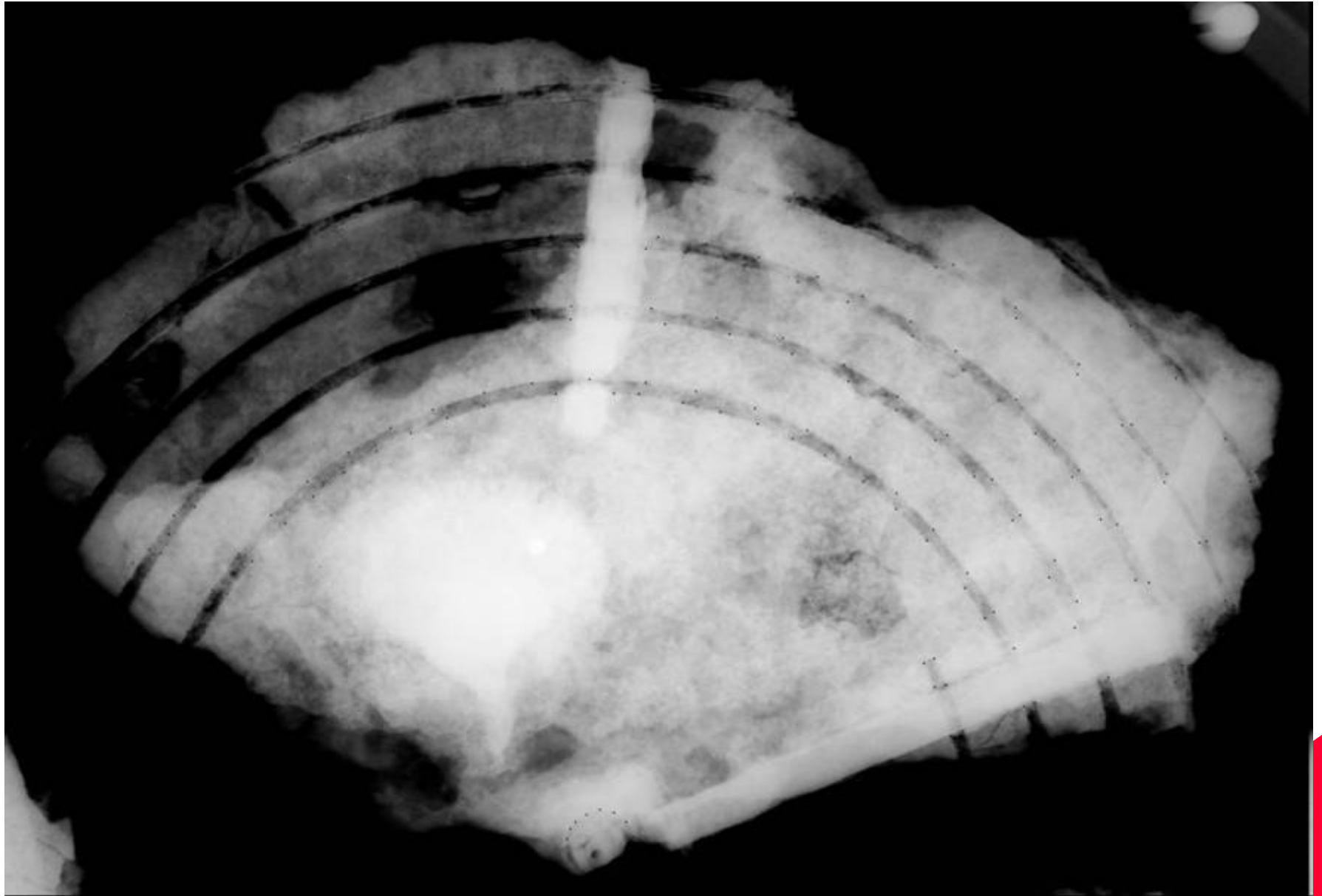


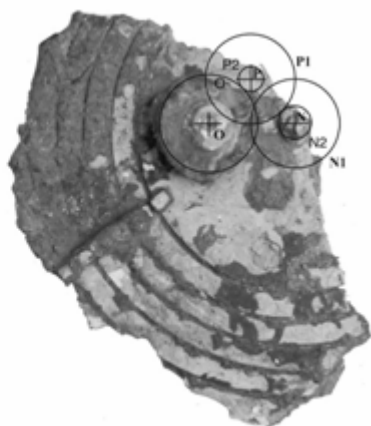
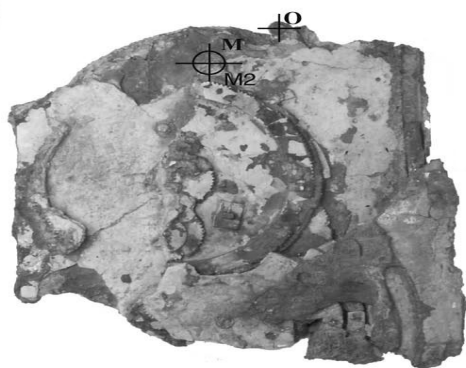
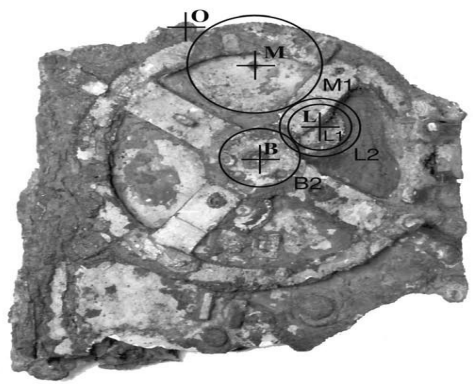


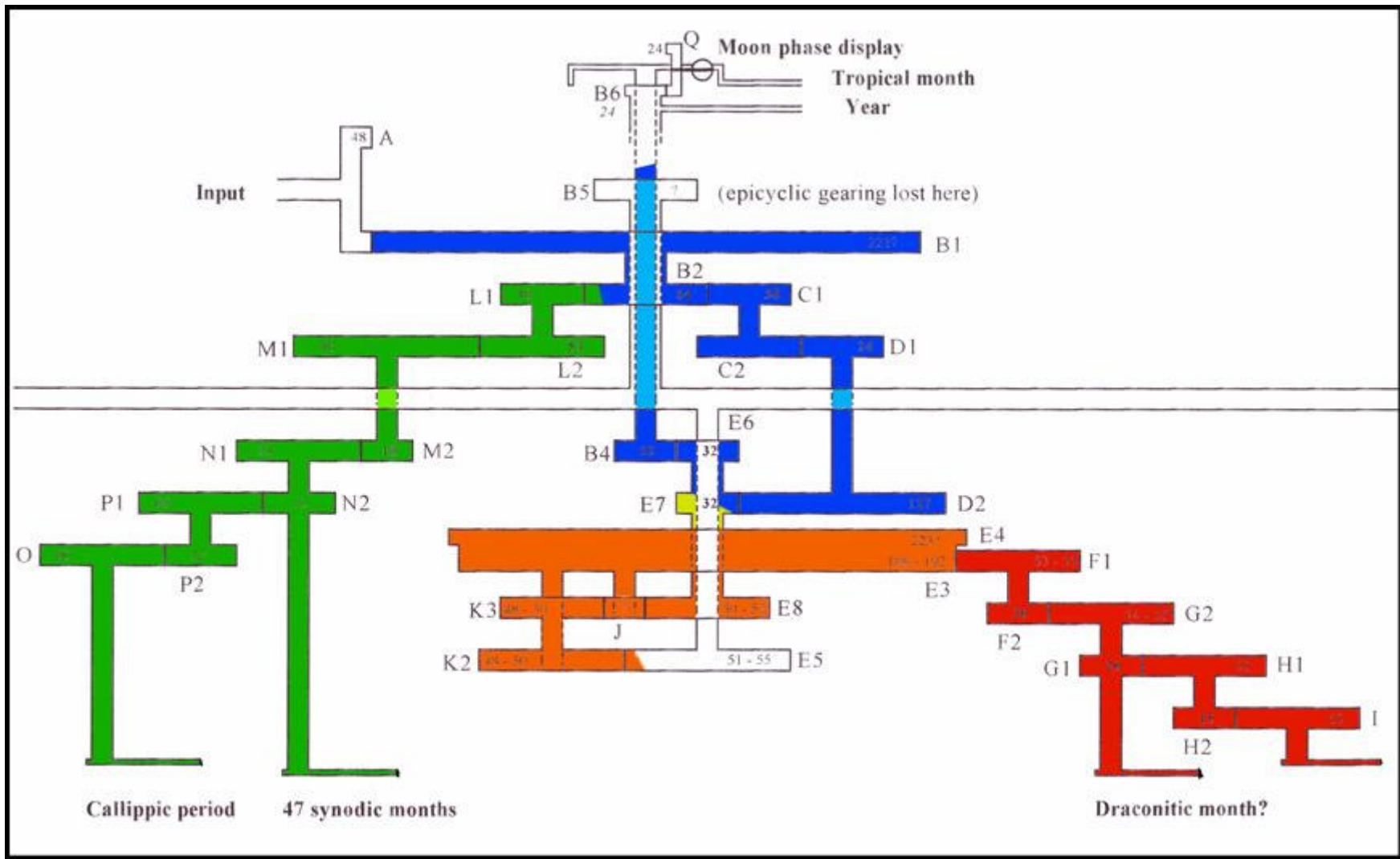














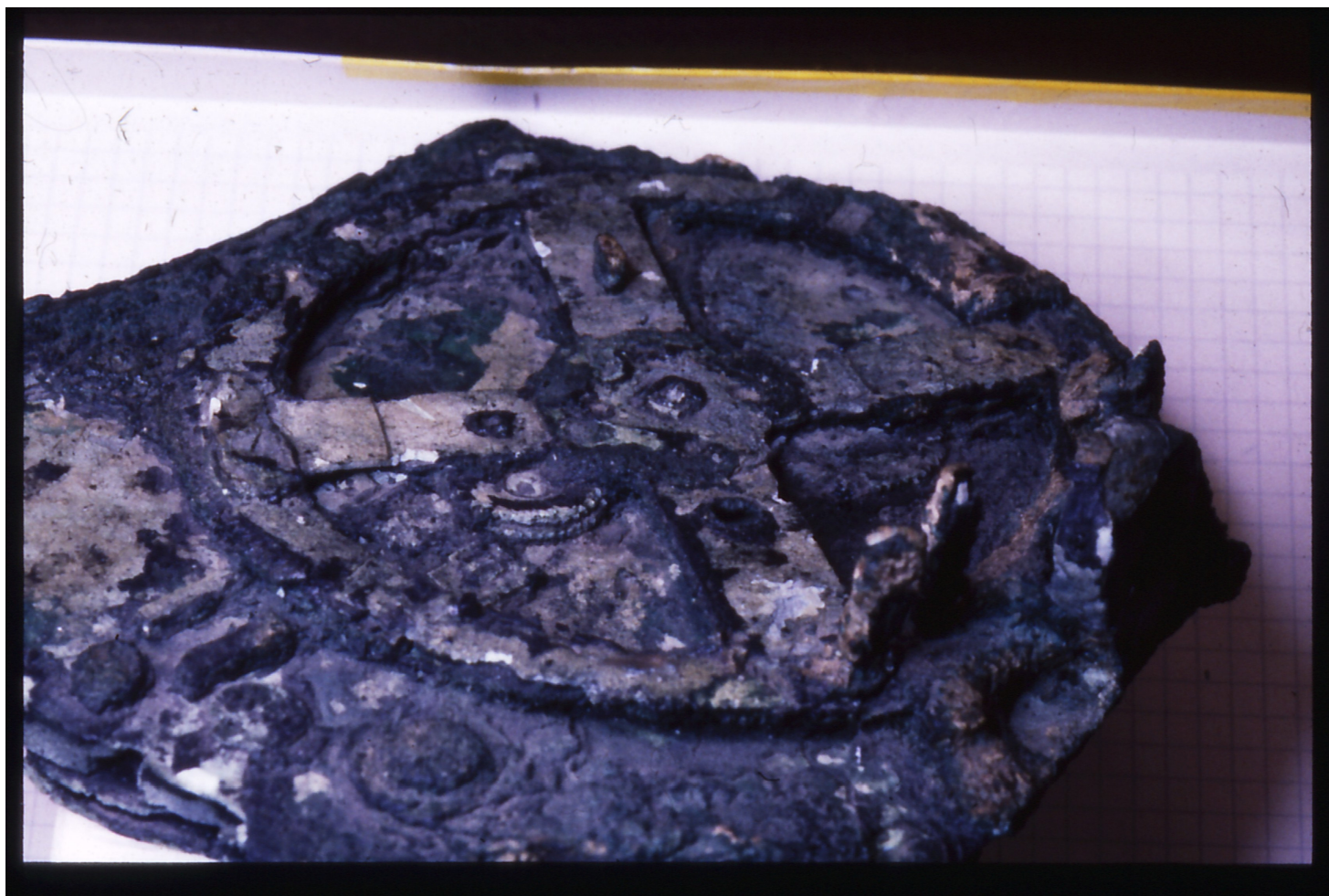


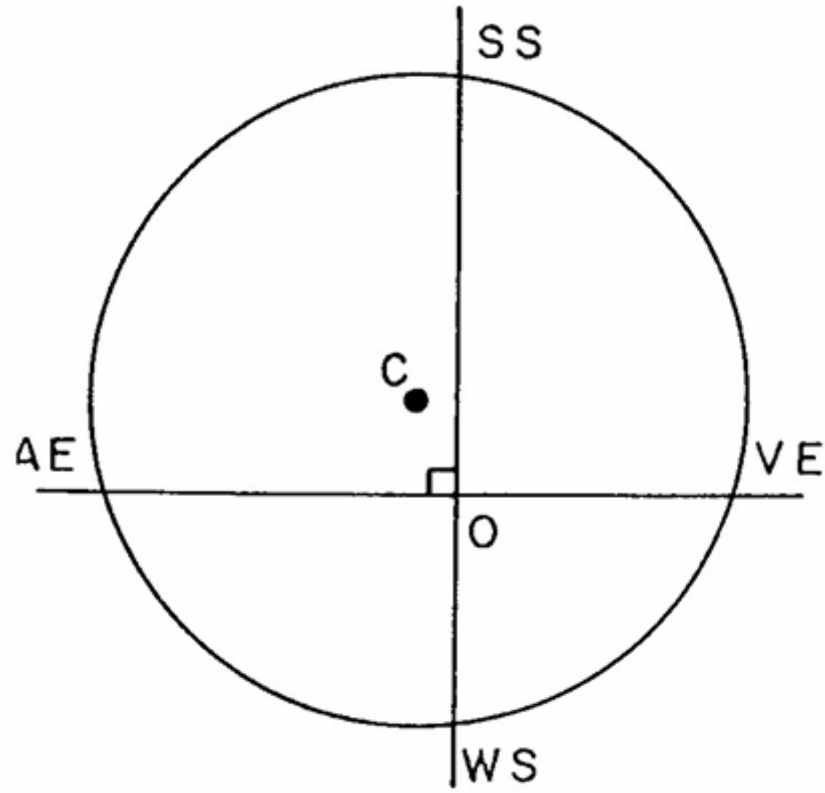


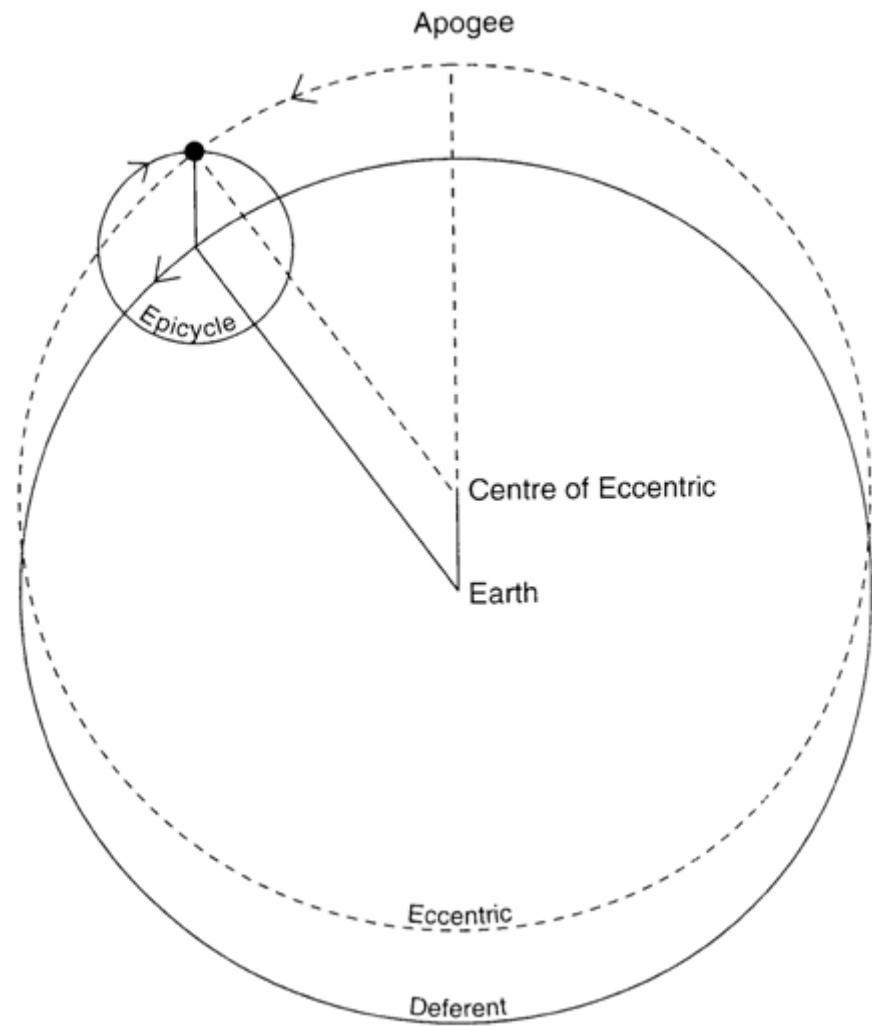


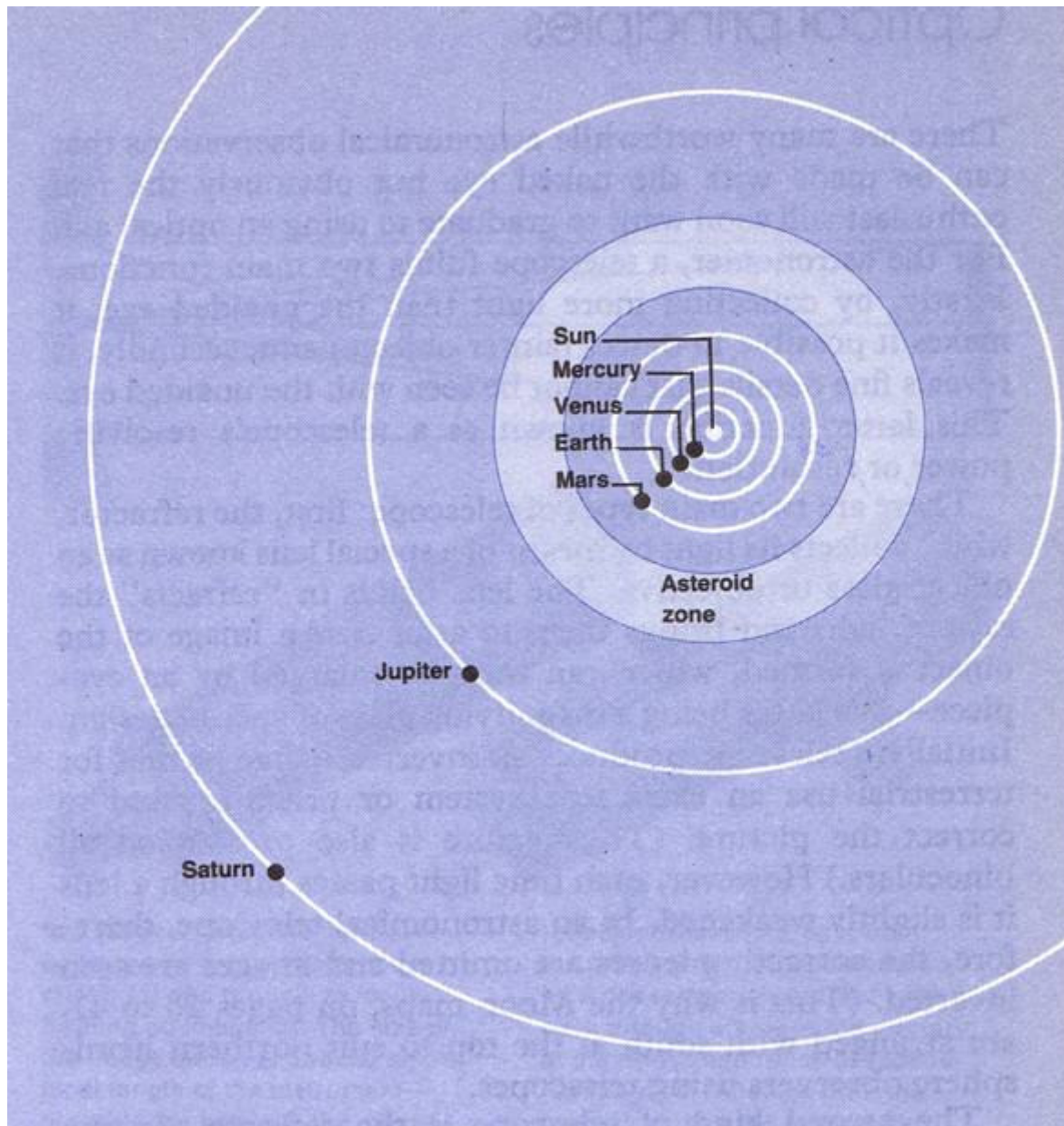


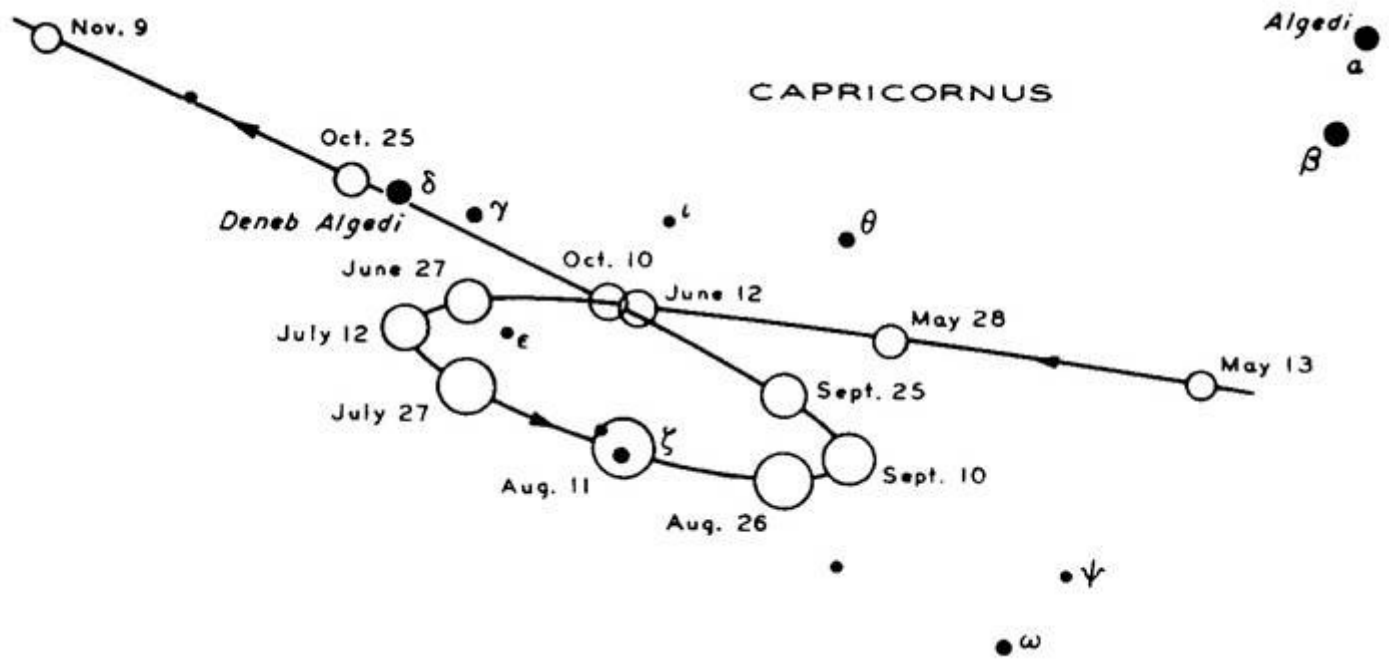


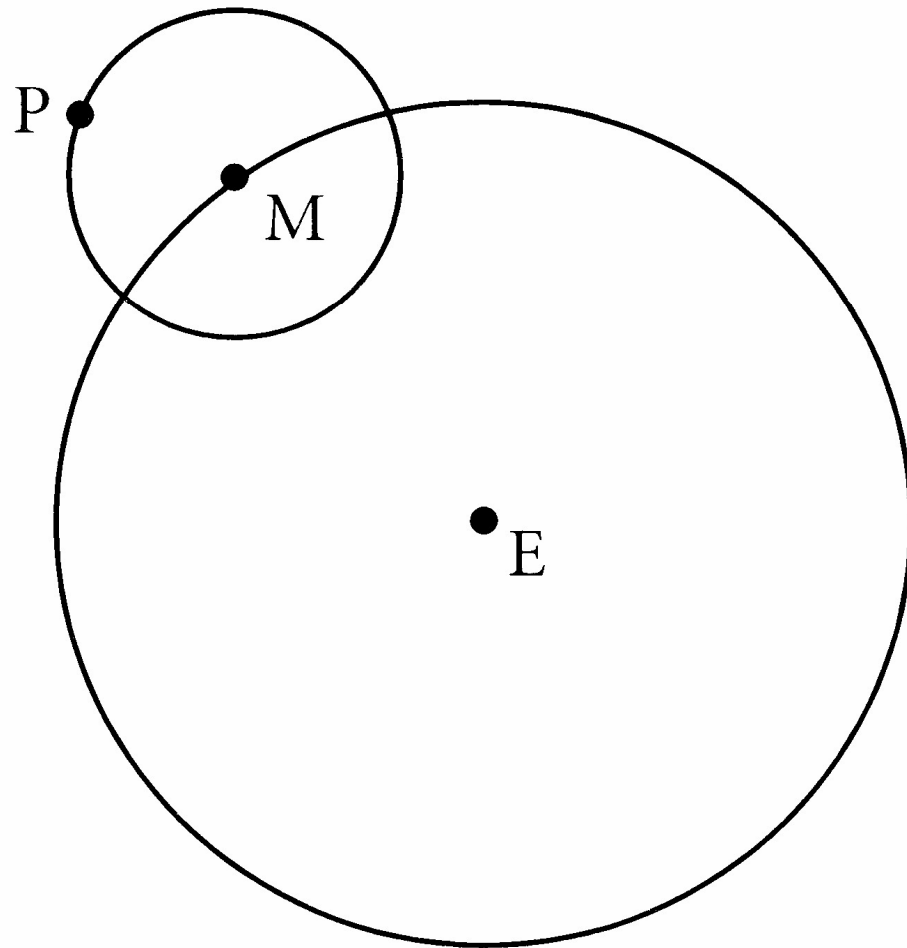














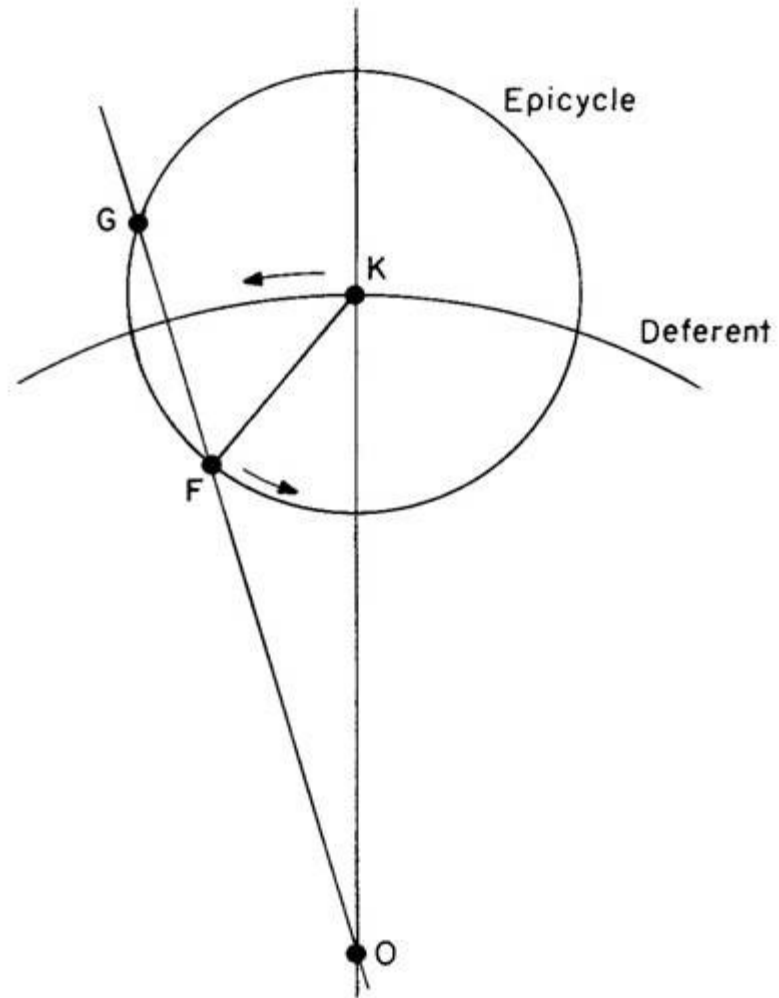


FIGURE 7.26. Illustrating Apollonius's theorem.



